



Electrical Information					
Model No.	ST40-030WS-3CS	ST40-050WS-3CS	ST40-060WS-3CS	ST40-075WS-2CS	ST40-150WS-3CS
Power Consumption (W)	30	50	60	75	150
Wattage Selectable	100% , 75% , 50% , 30% (Selectable)				100% , 80% , 60% (Selectable)
Power Supply	Becky				
Input Voltage	120-277 Vac, 120-347 Vac, 50/60 Hz				
Power Factor	>0.9				
Surge Protection	6kV line-line, 6kV line-earth				
Driver Type	Constant current (CC)				
Control	Dimmable Photocell				
Note	NA				

* The tolerance for power is ±5%.

Optic Information					
LED Type	LED 3030				
Luminous Flux (lm)(4000K)	4500	7500	9000	11250	22500
Efficacy (lm/w)(4000K)	150				
Correlated Color Temperature	3000K, 4000K, 5000K (selectable)			4000K, 5000K (selectable)	3000K, 4000K, 5000K (selectable)
Color Rendering Index	Ra70 (Ra80 optional)				
Beam Angle	R01603, R01604, R01605				
UGR level	N/A				

* The tolerance for luminous flux is ±10%.

Description

The ST40 series post-top light is the ultimate choice for outdoor lighting, adding elegance to any landscape or street. In parks and walkways, it not only highlights features but also boosts safety, providing a consistent glow for better visibility.

Key Features

- Contemporary and architectural design.
- Compatible with the most popular mounting types, such as single strut, twin strut, post top, side entry, etc.
- High output efficiency up to 150lm/w.
- 3 kinds of optional optic lenses available.
- Special outdoor powder coating for enhanced anti-corrosion.
- Toolless maintenance.
- CCT&Power Adjustable
- Compatible with NEMA sockets.
- Dark Sky Approved when set to 3K

Applications

- Roadway
- Parks
- Public square
- Private garden
- Residential area
- Walkway, pathway

Dimensions and Mount

Product Dimension (mm/inch)	φ400x81/ φ15.75"x3.19"	φ400x92/ φ15.75"x3.62"
Luminaire Net Weight (kg/lbs)	5.3/11.68	6.1/13.45
Export Carton Size (mm/inch)	460x460x155/18.11"x18.11"x6.1"	
Gross Weight (kg/lbs)	6.5/14.33	7.7/16.98
Mounting Option	Single strut mounting, Twin strut mounting, Straight-arm mounting, Wall mounting, Post top mounting, Gooseneck mounting, Conduit mounting, Surface mounting, Side entry mounting	
Material	Aluminum alloy Tempered glass+polycarbonate optical lens	
Finish	Powder coating	
Fixture Color	Black(RAL9005)	
EPA (m²/ft²)	0.11/1.15	
IK Rating	IK08	
IP Rating	IP66	

* The tolerance for weight is ±6%.

Lifespan and Warranty

Operating Temperature (°C/°F)	-30 to +50/(-22 to +122)
Lifespan of LED @Ta=25°C (hours)	L90-43000
	L80-89000
	L70-142000
Warranty (years)	5

New Features

* Please consult us for details.

Photometry

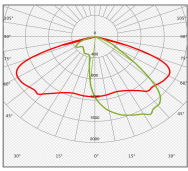

R01603 (TypeII)

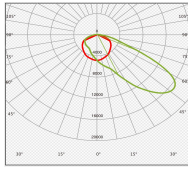

R01604 (TypeIII)

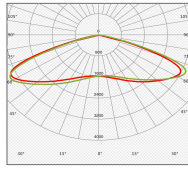

R01605 (TypeV)

Mounting Options



Single strut mounting



Twin strut mounting



Straight-arm mounting
/Wall mounting



Post top mounting



Gooseneck mounting



Conduit mounting









Surface mounting



Side entry mounting

Product Code List

Mounting Option	Min.Power	QTY/CTN	NW (± 0.3kg/ ± 0.66Lbs)	GW(± 0.3kg/ ± 0.66Lbs)	Export Carton Size(mm/inch)
Single strut		5	8kg (17.6Lbs)	11kg (24.2Lbs)	520x520x275mm (20.47x20.47x10.82")
Twin strut		5	9kg (19.8Lbs)	12.5kg (27.6Lbs)	500x550x335mm (19.7x21.6x13.2")
Straight-arm bracket		15	18kg (39.7Lbs)	21.3kg (47Lbs)	610x540x240mm (24.0x21.3x9.4")
Slip fitter bracket		15	18kg (39.7Lbs)	20.1kg (44.3Lbs)	420x270x335mm (16.5x10.6x13.2")
Gooseneck bracket		20	10kg (22.0Lbs)	12.5kg (27.6Lbs)	360x280x285mm (14.2x11x11.2")
Conduit mount		20	9kg (19.8Lbs)	10.4kg (22.9Lbs)	285x285x310mm (11.2x11.2x12.2")
Surface mount		10	9kg (19.8Lbs)	10.1kg (22.3Lbs)	520x390x245mm (20.5x15.6x9.6")

* The light distribution will be different due to the different mounting brackets.

Dimensions

Unit:mm/inch

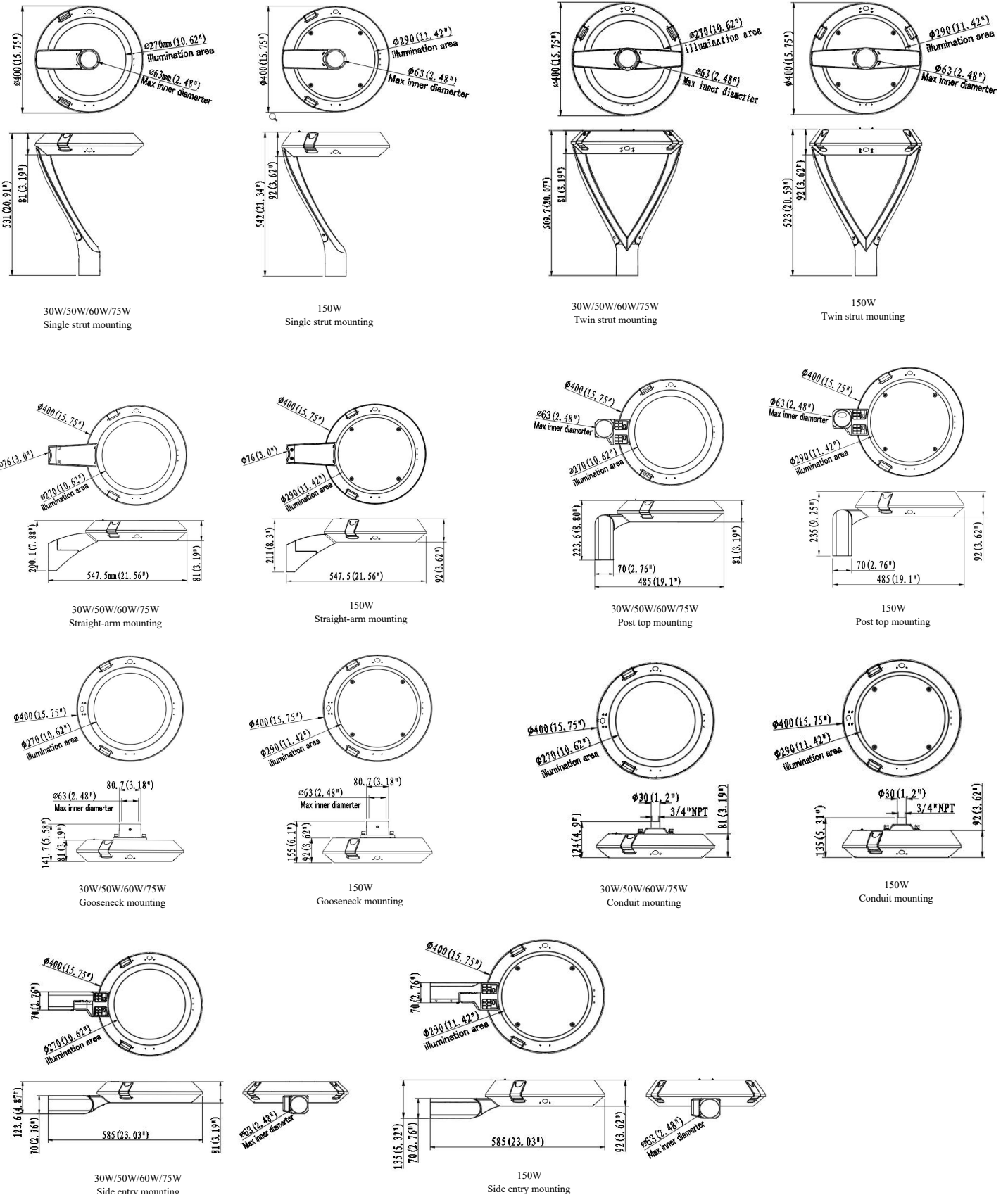

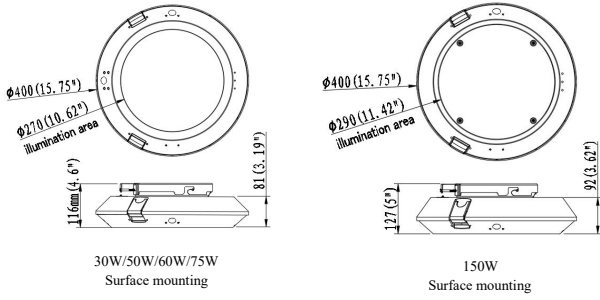

Accessories



Shorting cap
Cover NEMA socket when it is not used.
Code: NS-A00-01



Photocell control
ANSI C136.10-1996 Twist Lock for On-Off function only.
Code: PS-A00-01



Single strut
ADC12 materials with outdoor powder coating. for dia.60mm pole.
Compatible with heat sink A.
Code:SP-R40-04



Twin strut
ADC12 materials with outdoor powder coating. for dia.60mm pole.
Compatible with heat sink A.
Code:SP-R40-05



Slip fitter bracket
ADC12 materials with outdoor powder coating. for dia.60mm pole.
Compatible with heat sink A.
Code:SP-R40-03



Straight-arm bracket
ADC12 materials with outdoor powder coating. for dia.60mm pole, for 74mm square pole.
Compatible with heat sink A.
Code:SP-R40-02



Gooseneck bracket
ADC12 materials with outdoor powder coating. for dia.60mm pole.
Compatible with heat sink A.
Code:SP-R40-01



Conduit mounting
SPCC materials with outdoor powder coating.
Code:SP-R40-08



Surface mount
SPCC materials with outdoor powder coating.
Code:SP-R40-07